



**DIVISION: 03 00 00—CONCRETE**  
**Section: 03 16 00—Concrete Anchors**

**DIVISION: 05 00 00—METALS**  
**Section: 05 05 19—Post-Installed Concrete Anchors**

**REPORT HOLDER:**

HILTI, INC.

**EVALUATION SUBJECT:**

**HILTI KWIK BOLT TZ CARBON AND STAINLESS STEEL ANCHORS IN CRACKED AND UNCRACKED CONCRETE**

**1.0 EVALUATION SCOPE**

**Compliance with the following codes:**

- 2018, 2015, 2012 and 2009 *International Building Code*® (IBC)
- 2018, 2015, 2012 and 2009 *International Residential Code*® (IRC)
- 2013 *Abu Dhabi International Building Code* (ADIBC)†

†The ADIBC is based on the 2009 IBC. 2009 IBC code sections referenced in this report are the same sections in the ADIBC.

For evaluation for compliance with the *National Building Code of Canada*® (NBCC), see listing report [ELC-1917](#).

For evaluation for compliance with codes adopted by the Los Angeles Department of Building and Safety (LADBS), see [ESR-1917 LABC and LARC Supplement](#).

**Property evaluated:**

Structural

**2.0 USES**

The Hilti Kwik Bolt TZ anchor (KB-TZ) is used as anchorage to resist static, wind, and seismic (Seismic Design Categories A through F) tension and shear loads in cracked and uncracked normal-weight concrete and lightweight concrete having a specified compressive strength,  $f_c$ , of 2,500 psi to 8,500 psi (17.2 MPa to 58.6 MPa) [minimum of 24 MPa is required under ADIBC Appendix L, Section 5.1.1].

The 3/8-inch- and 1/2-inch-diameter (9.5 mm and 12.7 mm) carbon steel KB-TZ anchors may be installed in the topside of cracked and uncracked normal-weight or sand-lightweight concrete-filled steel deck having a minimum member thickness,  $h_{min,deck}$ , as noted in Table 6 of this report and a specified compressive strength,  $f_c$ ,

of 3,000 psi to 8,500 psi (20.7 MPa to 58.6 MPa) [minimum of 24 MPa is required under ADIBC Appendix L, Section 5.1.1].

The 3/8-inch-, 1/2-inch-, 5/8-inch- and 3/4-inch diameter (9.5 mm, 12.7 mm and 15.9 mm) carbon steel KB-TZ anchors may be installed in the soffit of cracked and uncracked normal-weight or sand-lightweight concrete over metal deck having a minimum specified compressive strength,  $f_c$ , of 3,000 psi (20.7 MPa) [minimum of 24 MPa is required under ADIBC Appendix L, Section 5.1.1].

The anchoring system complies with anchors as described in Section 1901.3 of the 2018 and 2015 IBC, Section 1909 of the 2012 IBC, and Section 1912 of the 2009 IBC. The anchoring system is an alternative to cast-in-place anchors described in Section 1908 of the 2012 IBC, and Section 1911 of the 2009 IBC. The anchors may also be used where an engineered design is submitted in accordance with Section R301.1.3 of the IRC.

**3.0 DESCRIPTION**

**3.1 KB-TZ:**

KB-TZ anchors are torque-controlled, mechanical expansion anchors. KB-TZ anchors consist of a stud (anchor body), wedge (expansion elements), nut, and washer. The anchor (carbon steel version) is illustrated in Figure 1. The stud is manufactured from carbon steel or AISI Type 304 or Type 316 stainless steel materials. Carbon steel KB-TZ anchors have a minimum 5  $\mu$ m (0.0002 inch) zinc plating. The expansion elements for the carbon and stainless steel KB-TZ anchors are fabricated from Type 316 stainless steel. The hex nut for carbon steel conforms to ASTM A563-04, Grade A, and the hex nut for stainless steel conforms to ASTM F594.

The anchor body is comprised of a high-strength rod threaded at one end and a tapered mandrel at the other end. The tapered mandrel is enclosed by a three-section expansion element which freely moves around the mandrel. The expansion element movement is restrained by the mandrel taper and by a collar. The anchor is installed in a predrilled hole with a hammer. When torque is applied to the nut of the installed anchor, the mandrel is drawn into the expansion element, which is in turn expanded against the wall of the drilled hole.

**3.2 Concrete:**

Normal-weight and lightweight concrete must conform to Sections 1903 and 1905 of the IBC.

**3.3 Steel Deck Panels:**

Steel deck panels must be in accordance with the

configuration in Figures 5A, 5B, 5C and 5D and have a minimum base steel thickness of 0.035 inch (0.899 mm). Steel must comply with ASTM A653/A653M SS Grade 33 and have a minimum yield strength of 33,000 psi (228 MPa).

## 4.0 DESIGN AND INSTALLATION

### 4.1 Strength Design:

**4.1.1 General:** Design strength of anchors complying with the 2018 and 2015 IBC, as well as Section R301.1.3 of the 2015 IRC must be determined in accordance with ACI 318-14 Chapter 17 and this report.

Design strength of anchors complying with the 2012 IBC as well as Section R301.1.3 of the 2012 IRC, must be determined in accordance with ACI 318-11 Appendix D and this report.

Design strength of anchors complying with the 2009 IBC and Section R301.1.3 of the 2009 IRC must be determined in accordance with ACI 318-08 Appendix D and this report.

Design parameters provided in Tables 3, 4, 5 and 6 of this report are based on the 2018 and 2015 IBC (ACI 318-14) and the 2012 IBC (ACI 318-11) unless noted otherwise in Sections 4.1.1 through 4.1.12. The strength design of anchors must comply with ACI 318-14 17.3.1 or ACI 318-11 D.4.1, as applicable, except as required in ACI 318-14 17.2.3 or ACI 318-11 D.3.3, as applicable.

Strength reduction factors,  $\phi$ , as given in ACI 318-14 17.3.3 or ACI 318-11 D.4.3, as applicable, and noted in Tables 3 and 4 of this report, must be used for load combinations calculated in accordance with Section 1605.2 of the IBC and Section 5.3 of ACI 318-14 or Section 9.2 of ACI 318-11, as applicable. Strength reduction factors,  $\phi$ , as given in ACI 318-11 D.4.4 must be used for load combinations calculated in accordance with ACI 318-11 Appendix C. An example calculation in accordance with the 2018, 2015 and 2012 IBC is provided in Figure 8. The value of  $f'_c$  used in the calculations must be limited to a maximum of 8,000 psi (55.2 MPa), in accordance with ACI 318-14 17.2.7 or ACI 318-11 D.3.7, as applicable.

**4.1.2 Requirements for Static Steel Strength in Tension:** The nominal static steel strength,  $N_{sa}$ , of a single anchor in tension must be calculated in accordance with ACI 318-14 17.4.1.2 or ACI 318-11 D.5.1.2, as applicable. The resulting  $N_{sa}$  values are provided in Tables 3 and 4 of this report. Strength reduction factors  $\phi$  corresponding to ductile steel elements may be used.

**4.1.3 Requirements for Static Concrete Breakout Strength in Tension:** The nominal concrete breakout strength of a single anchor or group of anchors in tension,  $N_{cb}$  or  $N_{cbg}$ , respectively, must be calculated in accordance with ACI 318-14 17.4.2 or ACI 318-11 D.5.2, as applicable, with modifications as described in this section. The basic concrete breakout strength in tension,  $N_b$ , must be calculated in accordance with ACI 318-14 17.4.2.2 or ACI 318-11 D.5.2.2, as applicable, using the values of  $h_{ef}$  and  $k_{cr}$  as given in Tables 3, 4 and 6. The nominal concrete breakout strength in tension in regions where analysis indicates no cracking in accordance with ACI 318-14 17.4.2.6 or ACI 318-11 D.5.2.6, as applicable, must be calculated with  $k_{uncr}$  as given in Tables 3 and 4 and with  $\psi_{c,N} = 1.0$ .

For carbon steel KB-TZ anchors installed in the soffit of sand-lightweight or normal-weight concrete on steel deck floor and roof assemblies, as shown in Figures 5A, 5B and 5C, calculation of the concrete breakout strength is not required.

**4.1.4 Requirements for Static Pullout Strength in Tension:** The nominal pullout strength of a single anchor in accordance with ACI 318-14 17.4.3.1 and 17.4.3.2 or ACI 318-11 D.5.3.1 and D.5.3.2, respectively, as applicable, in cracked and uncracked concrete,  $N_{p,cr}$  and  $N_{p,uncr}$ , respectively, is given in Tables 3 and 4. For all design cases  $\psi_{c,P} = 1.0$ . In accordance with ACI 318-14 17.4.3 or ACI 318-11 D.5.3, as applicable, the nominal pullout strength in cracked concrete may be calculated in accordance with the following equation:

$$N_{p,f'_c} = N_{p,cr} \sqrt{\frac{f'_c}{2,500}} \quad (\text{lb, psi}) \quad (\text{Eq-1})$$

$$N_{p,f'_c} = N_{p,cr} \sqrt{\frac{f'_c}{17.2}} \quad (\text{N, MPa})$$

In regions where analysis indicates no cracking in accordance with ACI 318-14 17.4.3.6 or ACI 318-11 D.5.3.6, as applicable, the nominal pullout strength in tension may be calculated in accordance with the following equation:

$$N_{p,f'_c} = N_{p,uncr} \sqrt{\frac{f'_c}{2,500}} \quad (\text{lb, psi}) \quad (\text{Eq-2})$$

$$N_{p,f'_c} = N_{p,uncr} \sqrt{\frac{f'_c}{17.2}} \quad (\text{N, MPa})$$

Where values for  $N_{p,cr}$  or  $N_{p,uncr}$  are not provided in Table 3 or Table 4, the pullout strength in tension need not be evaluated.

The nominal pullout strength in cracked concrete of the carbon steel KB-TZ installed in the soffit of sand-lightweight or normal-weight concrete on steel deck floor and roof assemblies, as shown in Figures 5A, 5B and 5C, is given in Table 5. In accordance with ACI 318-14 17.4.3.2 or ACI 318-11 D.5.3.2, as applicable, the nominal pullout strength in cracked concrete must be calculated in accordance with Eq-1, whereby the value of  $N_{p,deck,cr}$  must be substituted for  $N_{p,cr}$  and the value of 3,000 psi (20.7 MPa) must be substituted for the value of 2,500 psi (17.2 MPa) in the denominator. In regions where analysis indicates no cracking in accordance with ACI 318-14 17.4.3.6 or ACI 318-11 D.5.3.6, as applicable, the nominal strength in uncracked concrete must be calculated according to Eq-2, whereby the value of  $N_{p,deck,uncr}$  must be substituted for  $N_{p,uncr}$  and the value of 3,000 psi (20.7 MPa) must be substituted for the value of 2,500 psi (17.2 MPa) in the denominator. The use of stainless steel KB-TZ anchors installed in the soffit of concrete on steel deck assemblies is beyond the scope of this report.

**4.1.5 Requirements for Static Steel Strength in Shear:** The nominal steel strength in shear,  $V_{sa}$ , of a single anchor in accordance with ACI 318-14 17.5.1.2 or ACI 318-11 D.6.1.2, as applicable, is given in Table 3 and Table 4 of this report and must be used in lieu of the values derived by calculation from ACI 318-14 Eq. 17.5.1.2b or ACI 318-11 Eq. D-29, as applicable. The shear strength  $V_{sa,deck}$  of the carbon-steel KB-TZ as governed by steel failure of the KB-TZ installed in the soffit of sand-lightweight or normal-weight concrete on steel deck floor and roof assemblies, as shown in Figures 5A, 5B and 5C, is given in Table 5.

**4.1.6 Requirements for Static Concrete Breakout Strength in Shear:** The nominal concrete breakout strength of a single anchor or group of anchors in shear,  $V_{cb}$  or  $V_{cbg}$ , respectively, must be calculated in accordance with ACI 318-14 17.5.2 or ACI 318-11 D.6.2, as applicable, with modifications as described in this section. The basic

concrete breakout strength,  $V_b$ , must be calculated in accordance with ACI 318-14 17.5.2.2 or ACI 318-11 D.6.2.2, as applicable, based on the values provided in Tables 3 and 4. The value of  $\ell_e$  used in ACI 318-14 Eq. 17.5.2.2a or ACI 318-11 Eq. D-33 must be taken as no greater than the lesser of  $h_{ef}$  or  $8d_a$ .

For carbon steel KB-TZ anchors installed in the soffit of sand-lightweight or normal-weight concrete on steel deck floor and roof assemblies, as shown in Figures 5A, 5B and 5C, calculation of the concrete breakout strength in shear is not required.

**4.1.7 Requirements for Static Concrete Pryout Strength in Shear:** The nominal concrete pryout strength of a single anchor or group of anchors,  $V_{cp}$  or  $V_{cp,g}$ , respectively, must be calculated in accordance with ACI 318-14 17.5.3 or ACI 318-11 D.6.3, as applicable, modified by using the value of  $K_{cp}$  provided in Tables 3 and 4 of this report and the value of  $N_{cb}$  or  $N_{cb,g}$  as calculated in Section 4.1.3 of this report.

For carbon steel KB-TZ anchors installed in the soffit of sand-lightweight or normal-weight concrete over profile steel deck floor and roof assemblies, as shown in Figures 5A, 5B, and 5C, calculation of the concrete pry-out strength in accordance with ACI 318-14 17.5.3 or ACI 318-11 D.6.3 is not required.

#### 4.1.8 Requirements for Seismic Design:

**4.1.8.1 General:** For load combinations including seismic, the design must be performed in accordance with ACI 318-14 17.2.3 or ACI 318-11 D.3.3, as applicable. Modifications to ACI 318-14 17.2.3 shall be applied under Section 1905.1.8 of the 2018 and 2015 IBC. For the 2012 IBC, Section 1905.1.9 shall be omitted. Modifications to ACI 318 (-08, -05) D.3.3 shall be applied under Section 1908.1.9 of the 2009 IBC, as applicable.

The anchors comply with ACI 318-14 2.3 or ACI 318-11 D.1, as applicable, as ductile steel elements and must be designed in accordance with ACI 318-14 17.2.3.4, 17.2.3.5, 17.2.3.6 or 17.2.3.7; or ACI 318-11 D.3.3.4, D.3.3.5, D.3.3.6 or D.3.3.7; ACI 318-08 D.3.3.4, D.3.3.5 or D.3.3.6, as applicable. Strength reduction factors,  $\phi$ , are given in Tables 3 and 4 of this report. The anchors may be installed in Seismic Design Categories A through F of the IBC.

**4.1.8.2 Seismic Tension:** The nominal steel strength and nominal concrete breakout strength for anchors in tension must be calculated in accordance with ACI 318-14 17.4.1 and 17.4.2 or ACI 318-11 D.5.1 and D.5.2, as applicable, as described in Sections 4.1.2 and 4.1.3 of this report. In accordance with ACI 318-14 17.4.3.2 or ACI 318-11 D.5.3.2, as applicable, the appropriate pullout strength in tension for seismic loads,  $N_{p,eq}$ , described in Table 4 or  $N_{p,deck,cr}$  described in Table 5 must be used in lieu of  $N_p$ , as applicable. The value of  $N_{p,eq}$  or  $N_{p,deck,cr}$  may be adjusted by calculation for concrete strength in accordance with Eq-1 and Section 4.1.4 whereby the value of  $N_{p,deck,cr}$  must be substituted for  $N_{p,cr}$  and the value of 3,000 psi (20.7 MPa) must be substituted for the value of 2,500 psi (17.2 MPa) in the denominator. If no values for  $N_{p,eq}$  are given in Table 3 or Table 4, the static design strength values govern.

**4.1.8.3 Seismic Shear:** The nominal concrete breakout strength and pryout strength in shear must be calculated in accordance with ACI 318-14 17.5.2 and 17.5.3 or ACI 318-11 D.6.2 and D.6.3, respectively, as applicable, as described in Sections 4.1.6 and 4.1.7 of this report. In accordance with ACI 318-14 17.5.1.2 or ACI 318-11

D.6.1.2, as applicable, the appropriate value for nominal steel strength for seismic loads,  $V_{sa,eq}$  described in Table 3 and Table 4 or  $V_{sa,deck}$  described in Table 5 must be used in lieu of  $V_{sa}$ , as applicable.

**4.1.9 Requirements for Interaction of Tensile and Shear Forces:** For anchors or groups of anchors that are subject to the effects of combined tension and shear forces, the design must be performed in accordance with ACI 318-14 17.6 or ACI 318-11 D.7, as applicable.

**4.1.10 Requirements for Minimum Member Thickness, Minimum Anchor Spacing and Minimum Edge Distance:** In lieu of ACI 318-14 17.7.1 and 17.7.3 or ACI 318-11 D.8.1 and D.8.3, respectively, as applicable, values of  $s_{min}$  and  $c_{min}$  as given in Tables 3 and 4 of this report must be used. In lieu of ACI 318-14 17.7.5 or ACI 318-11 D.8.5, as applicable, minimum member thicknesses  $h_{min}$  as given in Tables 3 and 4 of this report must be used. Additional combinations for minimum edge distance,  $c_{min}$ , and spacing,  $s_{min}$ , may be derived by linear interpolation between the given boundary values as described in Figure 4.

For carbon steel KB-TZ anchors installed on the top of normal-weight or sand-lightweight concrete over profile steel deck floor and roof assemblies, the anchor must be installed in accordance with Table 6 and Figure 5D.

For carbon steel KB-TZ anchors installed in the soffit of sand-lightweight or normal-weight concrete over profile steel deck floor and roof assemblies, the anchors must be installed in accordance with Figure 5A, 5B and 5C and shall have an axial spacing along the flute equal to the greater of  $3h_{ef}$  or 1.5 times the flute width.

**4.1.11 Requirements for Critical Edge Distance:** In applications where  $c < c_{ac}$  and supplemental reinforcement to control splitting of the concrete is not present, the concrete breakout strength in tension for uncracked concrete, calculated in accordance with ACI 318-14 17.4.2 or ACI 318-11 D.5.2, as applicable, must be further multiplied by the factor  $\Psi_{cp,N}$  as given by Eq-1:

$$\Psi_{cp,N} = \frac{c}{c_{ac}} \quad (\text{Eq-3})$$

whereby the factor  $\Psi_{cp,N}$  need not be taken as less than  $\frac{1.5h_{ef}}{c_{ac}}$ . For all other cases,  $\Psi_{cp,N} = 1.0$ . In lieu of using ACI 318-14 17.7.6 or ACI 318-11 D.8.6, as applicable, values of  $c_{ac}$  must comply with Table 3 or Table 4 and values of  $c_{ac,deck}$  must comply with Table 6.

**4.1.12 Lightweight Concrete:** For the use of anchors in lightweight concrete, the modification factor  $\lambda_a$  equal to  $0.8\lambda$  is applied to all values of  $\sqrt{f'_c}$  affecting  $N_n$  and  $V_n$ .

For ACI 318-14 (2018 and 2015 IBC), ACI 318-11 (2012 IBC) and ACI 318-08 (2009 IBC),  $\lambda$  shall be determined in accordance with the corresponding version of ACI 318.

For anchors installed in the soffit of sand-lightweight concrete-filled steel deck and floor and roof assemblies, further reduction of the pullout values provided in this report is not required.

#### 4.2 Allowable Stress Design (ASD):

**4.2.1 General:** Design values for use with allowable stress design (working stress design) load combinations calculated in accordance with Section 1605.3 of the IBC, must be established as follows:

$$T_{allowable,ASD} = \frac{\phi N_n}{\alpha}$$

$$V_{allowable,ASD} = \frac{\phi V_n}{\alpha}$$

where:

$T_{allowable,ASD}$  = Allowable tension load (lbf or kN).

$V_{allowable,ASD}$  = Allowable shear load (lbf or kN).

$\phi N_n$  = Lowest design strength of an anchor or anchor group in tension as determined in accordance with ACI 318-14 Chapter 17 and 2018 and 2015 IBC Section 1905.1.8, ACI 318-11 Appendix D, ACI 318-08 Appendix D and 2009 IBC Section 1908.1.9, and Section 4.1 of this report, as applicable (lbf or N).

$\phi V_n$  = Lowest design strength of an anchor or anchor group in shear as determined in accordance with ACI 318-14 Chapter 17 and 2018 and 2015 IBC Section 1905.1.8, ACI 318-11 Appendix D, ACI 318-08 Appendix D and 2009 IBC Section 1908.1.9, and Section 4.1 of this report, as applicable (lbf or N).

$\alpha$  = Conversion factor calculated as a weighted average of the load factors for the controlling load combination. In addition,  $\alpha$  must include all applicable factors to account for nonductile failure modes and required over-strength.

The requirements for member thickness, edge distance and spacing, described in this report, must apply. An example of allowable stress design values for illustrative purposes is shown in Table 7.

**4.2.2 Interaction of Tensile and Shear Forces:** The interaction must be calculated and consistent with ACI 318-14 17.6 or ACI 318-11 D.7, as applicable, as follows:

For shear loads  $V_{applied} \leq 0.2V_{allowable,ASD}$ , the full allowable load in tension must be permitted.

For tension loads  $T_{applied} \leq 0.2T_{allowable,ASD}$ , the full allowable load in shear must be permitted.

For all other cases:

$$\frac{T_{applied}}{T_{allowable,ASD}} + \frac{V_{applied}}{V_{allowable,ASD}} \leq 1.2 \quad (\text{Eq-4})$$

#### 4.3 Installation:

Installation parameters are provided in Tables 1A, 1B and 6 and Figures 2, 5A, 5B, 5C, and 5D. Anchor locations must comply with this report and plans and specifications approved by the code official. The Hilti KB-TZ must be installed in accordance with manufacturer's published instructions and this report. In case of conflict, this report governs. Anchors must be installed in holes drilled into the concrete using carbide-tipped masonry drill bits complying with ANSI B212.15-1994 or using the Hilti SafeSet System™ with Hilti TE-YD or TE-CD Hollow Drill Bits complying with ANSI B212.15-1994 with a Hilti vacuum with a minimum value for the maximum volumetric flow rate of 129 CFM (61 l/s). The Hollow Drill Bits are not permitted for use with the 3/8" and 3/4" diameter KB-TZ anchors. The minimum drilled hole depth,  $h_o$ , is given in Tables 1A and 1B. When drilling dust is not removed after hole drilling, make sure to drill deep enough to achieve  $h_{nom}$  taking into account the depth of debris remaining in

the hole. If dust and debris is removed from the drilled hole with the Hilti TE-YD or TE-CD Hollow Drill Bits or compressed air or a manual pump,  $h_{nom}$  is achieved at the specified value of  $h_o$  noted in Tables 1A and 1B. The anchor must be hammered into the predrilled hole until  $h_{nom}$  is achieved. The nut must be hand-tightened against the washer until the torque values specified in Tables 1A and 1B are achieved. For installation in the soffit of concrete on steel deck assemblies, the hole diameter in the steel deck not exceed the diameter of the hole in the concrete by more than 1/8 inch (3.2 mm). For member thickness and edge distance restrictions for installations into the soffit of concrete on steel deck assemblies, see Figures 5A, 5B and 5C. The 3/8", 1/2", and 5/8" anchors may be installed using the Hilti Safe-Set™ System consisting of the Hilti SIW-6AT-A22 Impact Wrench used together with the Hilti SI-AT-A22 Adaptive Torque Module in accordance with the manufacturer's published installation instructions as shown in Figure 7A.

#### 4.4 Special Inspection:

Periodic special inspection is required in accordance with Section 1705.1.1 and Table 1705.3 of the 2018 and 2015 IBC and 2012 IBC; Section 1704.15 and Table 1704.4 of the 2009 IBC, as applicable. The special inspector must make periodic inspections during anchor installation to verify anchor type, anchor dimensions, concrete type, concrete compressive strength, anchor spacing, edge distances, concrete member thickness, tightening torque, hole dimensions, anchor embedment and adherence to the manufacturer's printed installation instructions. The special inspector must be present as often as required in accordance with the "statement of special inspection." Under the IBC, additional requirements as set forth in Sections 1705, 1706 and 1707 must be observed, where applicable.

#### 5.0 CONDITIONS OF USE

The Hilti KB-TZ anchors described in this report comply with the codes listed in Section 1.0 of this report, subject to the following conditions:

- 5.1 Anchor sizes, dimensions, minimum embedment depths and other installation parameters are as set forth in this report.
- 5.2 The anchors must be installed in accordance with the manufacturer's published instructions and this report. In case of conflict, this report governs.
- 5.3 Anchors must be limited to use in cracked and uncracked normal-weight concrete and lightweight concrete having a specified compressive strength,  $f'_c$ , of 2,500 psi to 8,500 psi (17.2 MPa to 58.6 MPa) [minimum of 24 MPa is required under ADIBC Appendix L, Section 5.1.1], and cracked and uncracked normal-weight or sand-lightweight concrete over metal deck having a minimum specified compressive strength,  $f'_c$ , of 3,000 psi (20.7 MPa) [minimum of 24 MPa is required under ADIBC Appendix L, Section 5.1.1].
- 5.4 The values of  $f'_c$  used for calculation purposes must not exceed 8,000 psi (55.1 MPa).
- 5.5 The concrete shall have attained its minimum design strength prior to installation of the anchors.
- 5.6 Strength design values must be established in accordance with Section 4.1 of this report.
- 5.7 Allowable design values are established in accordance with Section 4.2.
- 5.8 Anchor spacing and edge distance as well as

minimum member thickness must comply with Tables 3, 4, and 6, and Figures 4, 5A, 5B, 5C and 5D.

- 5.9** Prior to installation, calculations and details demonstrating compliance with this report must be submitted to the code official. The calculations and details must be prepared by a registered design professional where required by the statutes of the jurisdiction in which the project is to be constructed.
- 5.10** Since an ICC-ES acceptance criteria for evaluating data to determine the performance of expansion anchors subjected to fatigue or shock loading is unavailable at this time, the use of these anchors under such conditions is beyond the scope of this report.
- 5.11** Anchors may be installed in regions of concrete where cracking has occurred or where analysis indicates cracking may occur ( $f_t > f_r$ ), subject to the conditions of this report.
- 5.12** Anchors may be used to resist short-term loading due to wind or seismic forces in locations designated as Seismic Design Categories A through F of the IBC, subject to the conditions of this report.
- 5.13** Where not otherwise prohibited in the code, KB-TZ anchors are permitted for use with fire-resistance-rated construction provided that at least one of the following conditions is fulfilled:
- Anchors are used to resist wind or seismic forces only.
  - Anchors that support a fire-resistance-rated envelope or a fire-resistance-rated membrane are protected by approved fire-resistance-rated materials, or have been evaluated for resistance to fire exposure in accordance with recognized standards.
  - Anchors are used to support nonstructural elements.
- 5.14** Use of zinc-coated carbon steel anchors is limited to dry, interior locations.
- 5.15** Use of anchors made of stainless steel as specified in this report are permitted for exterior exposure and damp environments.
- 5.16** Use of anchors made of stainless steel as specified in this report are permitted for contact with preservative-treated and fire-retardant-treated wood.
- 5.17** Anchors are manufactured by Hilti AG under an approved quality-control program with inspections by ICC-ES.
- 5.18** Special inspection must be provided in accordance with Section 4.4.

## 6.0 EVIDENCE SUBMITTED

- 6.1** Data in accordance with the ICC-ES Acceptance Criteria for Mechanical Anchors in Concrete Elements (AC193), dated October 2017, (editorially revised April 2018), which incorporates requirements in ACI 355.2-07 / ACI 255.2-04 for use in cracked and uncracked concrete.
- 6.2** Quality-control documentation.

## 7.0 IDENTIFICATION

- 7.1** The anchors are identified by packaging labeled with the manufacturer's name (Hilti, Inc.) and contact information, anchor name, anchor size, and evaluation report number (ESR-1917). The anchors have the letters KB-TZ embossed on the anchor stud and four notches embossed into the anchor head, and these are visible after installation for verification.
- 7.2** The report holder's contact information is the following:

### HILTI, INC.

**7250 DALLAS PARKWAY, SUITE 1000  
PLANO, TEXAS 75024  
(918) 872-8000  
[www.hilti.com](http://www.hilti.com)  
[HiltiTechEng@us.hilti.com](mailto:HiltiTechEng@us.hilti.com)**

TABLE 1A—SETTING INFORMATION (CARBON STEEL ANCHORS)

SETTING INFORMATION	Symbol	Units	Nominal anchor diameter (in.)														
			3/8			1/2			5/8			3/4					
Anchor O.D.	$d_a$	In. (mm)	0.375 (9.5)			0.5 (12.7)			0.625 (15.9)			0.75 (19.1)					
Nominal bit diameter	$d_{bit}$	In.	3/8			1/2			5/8			3/4					
Effective min. embedment	$h_{ef}$	In. (mm)	1 1/2 (38)	2 (51)	2 3/4 (70)	2 (51)	3 1/4 (83)	3 1/8 (79)	4 (102)	3 1/4 (83)	3 3/4 (95)	4 3/4 (121)					
Nominal embedment	$h_{nom}$	in. (mm)	1 13/16 (46)	2 5/16 (59)	3 1/16 (78)	2 3/8 (60)	3 5/8 (91)	3 9/16 (91)	4 7/16 (113)	3 13/16 (97)	4 5/16 (110)	5 5/16 (136)					
Min. hole depth	$h_o$	In. (mm)	2 (51)	2 5/8 (67)	3 3/8 (86)	2 5/8 (67)	4 (102)	3 3/4 (95)	4 3/4 (121)	4 (102)	4 1/2 (114)	5 3/4 (146)					
Min. thickness of fastened part <sup>1</sup>	$t_{min}$	In. (mm)	0 (0)	0 (0)	0 (0)	3/4 (19)	1/4 (6)	3/8 (9)	3/4 (19)	0 (0)	0 (0)	7/8 (23)					
Required Installation torque <sup>2</sup>	$T_{inst}$	ft-lb (Nm)	25 (34)			40 (54)			60 (81)			110 (149)					
Min. dia. of hole in fastened part	$d_h$	In. (mm)	7/16 (11.1)			9/16 (14.3)			1 1/16 (17.5)			1 3/16 (20.6)					
Standard anchor lengths	$\ell_{anch}$	In. (mm)	3 (76)	3 3/4 (95)	5 (127)	3 3/4 (95)	4 1/2 (114)	5 1/2 (140)	7 (178)	4 3/4 (121)	6 (152)	8 1/2 (216)	10 (254)	5 1/2 (140)	7 (178)	8 (203)	10 (254)
Threaded length (incl. dog point)	$\ell_{thread}$	In. (mm)	1 1/2 (38)	2 1/4 (57)	3 1/2 (93)	1 5/8 (41)	2 3/8 (60)	3 3/8 (86)	4 7/8 (124)	1 1/2 (38)	2 3/4 (70)	5 1/4 (133)	6 3/4 (171)	2 1/2 (63)	4 (103)	5 (128)	7 (179)
Unthreaded length	$\ell_{unthr}$	In. (mm)	1 1/2 (39)			2 1/8 (54)			3 1/4 (83)			3 (77)					

<sup>1</sup>The minimum thickness of the fastened part is based on use of the anchor at minimum embedment and is controlled by the length of thread. If a thinner fastening thickness is required, increase the anchor embedment to suit.

<sup>2</sup>See section 4.3 for alternate installation with Hilti Safe-Set™ System consisting of the Hilti SIW-6AT-A22 Impact Wrench used together with the Hilti SI-AT-A22 Adaptive Torque Module.

TABLE 1B—SETTING INFORMATION (STAINLESS STEEL ANCHORS)

SETTING INFORMATION	Symbol	Units	Nominal anchor diameter (in.)													
			3/8			1/2			5/8			3/4				
Anchor O.D.	$d_a$	In. (mm)	0.375 (9.5)			0.5 (12.7)			0.625 (15.9)			0.75 (19.1)				
Nominal bit diameter	$d_{bit}$	In.	3/8			1/2			5/8			3/4				
Effective min. embedment	$h_{ef}$	In. (mm)	2 (51)			2 (51)	3 1/4 (83)	3 1/8 (79)	4 (102)	3 3/4 (95)	4 3/4 (121)					
Nominal embedment	$h_{nom}$	in. (mm)	2 5/16 (59)			2 3/8 (60)	3 5/8 (91)	3 9/16 (91)	4 7/16 (113)	4 5/16 (110)	5 5/16 (136)					
Min. hole depth	$h_o$	In. (mm)	2 5/8 (67)			2 5/8 (67)	4 (102)	3 3/4 (95)	4 3/4 (121)	4 1/2 (114)	5 3/4 (146)					
Min. thickness of fastened part <sup>1</sup>	$t_{min}$	In. (mm)	1/4 (6)			3/4 (19)	1/4 (6)	3/8 (9)	3/4 (19)	1/8 (3)	1 5/8 (41)					
Required Installation torque <sup>2</sup>	$T_{inst}$	ft-lb (Nm)	25 (34)			40 (54)			60 (81)			110 (149)				
Min. dia. of hole in fastened part	$d_h$	In. (mm)	7/16 (11.1)			9/16 (14.3)			1 1/16 (17.5)			1 3/16 (20.6)				
Standard anchor lengths	$\ell_{anch}$	In. (mm)	3 (76)	3 3/4 (95)	5 (127)	3 3/4 (95)	4 1/2 (114)	5 1/2 (140)	7 (178)	4 3/4 (121)	6 (152)	8 1/2 (216)	10 (254)	5 1/2 (140)	8 (203)	10 (254)
Threaded length (incl. dog point)	$\ell_{thread}$	In. (mm)	7/8 (22)	1 5/8 (41)	2 7/8 (73)	1 5/8 (41)	2 3/8 (60)	3 3/8 (86)	4 7/8 (124)	1 1/2 (38)	2 3/4 (70)	5 1/4 (133)	6 3/4 (171)	1 1/2 (38)	4 (102)	6 (152)
Unthreaded length	$\ell_{unthr}$	In. (mm)	2 1/8 (54)			2 1/8 (54)			3 1/4 (83)			4 (102)				

<sup>1</sup>The minimum thickness of the fastened part is based on use of the anchor at minimum embedment and is controlled by the length of thread. If a thinner fastening thickness is required, increase the anchor embedment to suit.

<sup>2</sup>See section 4.3 for alternate installation with Hilti Safe-Set™ System consisting of the Hilti SIW-6AT-A22 Impact Wrench used together with the Hilti SI-AT-A22 Adaptive Torque Module.

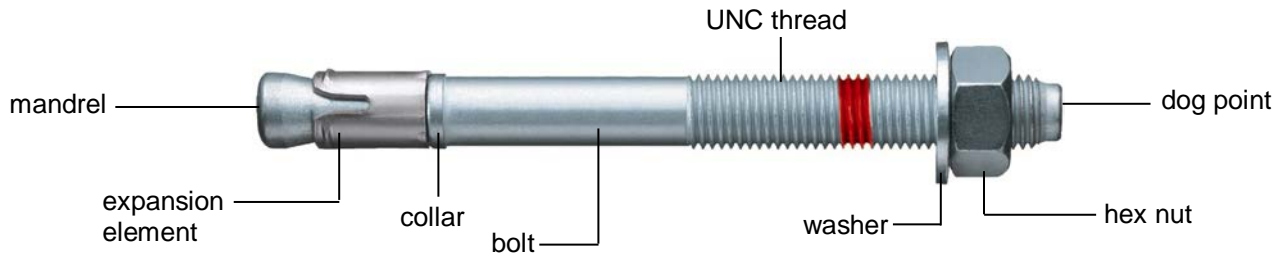

FIGURE 1—HILTI CARBON STEEL KWIK BOLT TZ (KB-TZ)

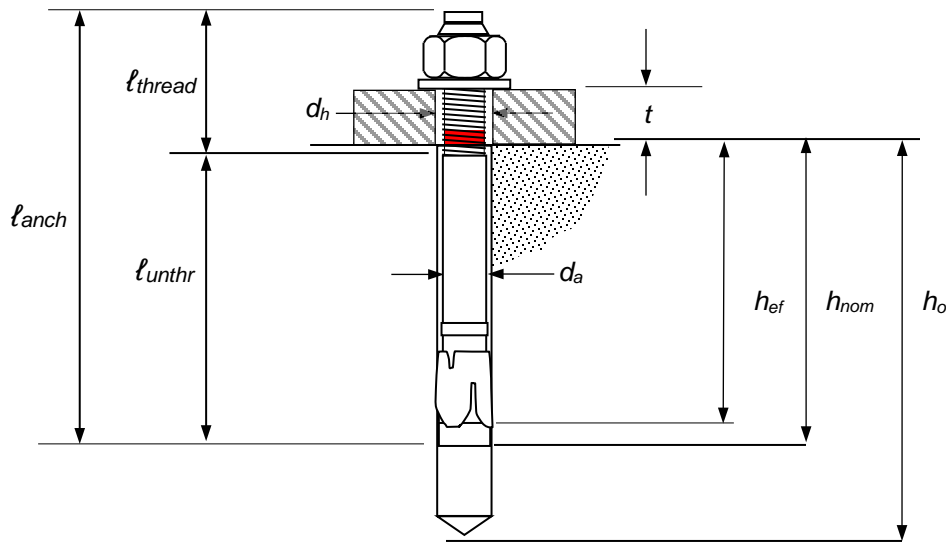

FIGURE 2—KB-TZ INSTALLED

TABLE 2—LENGTH IDENTIFICATION SYSTEM (CARBON STEEL AND STAINLESS STEEL ANCHORS)

Length ID marking on bolt head		A	B	C	D	E	F	G	H	I	J	K	L	M	N	O	P	Q	R	S	T	U	V	W
Length of anchor, $l_{anch}$ (inches)	From	1 ½	2	2 ½	3	3 ½	4	4 ½	5	5 ½	6	6 ½	7	7 ½	8	8 ½	9	9 ½	10	11	12	13	14	15
	Up to but not including	2	2 ½	3	3 ½	4	4 ½	5	5 ½	6	6 ½	7	7 ½	8	8 ½	9	9 ½	10	11	12	13	14	15	16



FIGURE 3—BOLT HEAD WITH LENGTH IDENTIFICATION CODE AND KB-TZ HEAD NOTCH EMBOSSEMENT

TABLE 3—DESIGN INFORMATION, CARBON STEEL KB-TZ

DESIGN INFORMATION	Symbol	Units	Nominal anchor diameter														
			3/8			1/2			5/8			3/4					
Anchor O.D.	$d_a$	in. (mm)	0.375 (9.5)			0.5 (12.7)			0.625 (15.9)			0.75 (19.1)					
Effective min. embedment <sup>1</sup>	$h_{ef}$	in. (mm)	1 1/2 (38)	2 (51)	2 3/4 (70)	2 (51)	3 1/4 (83)	3 1/8 (79)	4 (102)	3 1/4 (83)	3 3/4 (95)	4 3/4 (121)					
Min. member thickness <sup>2</sup>	$h_{min}$	in. (mm)	3 1/4 (83)	4 (102)	5 (127)	5 (127)	4 (102)	6 (152)	6 (152)	8 (203)	5 (127)	6 (152)	8 (203)	8 (203)			
Critical edge distance	$c_{ac}$	in. (mm)	6 (152)	4 3/8 (111)	4 (102)	4 1/8 (105)	5 1/2 (140)	4 1/2 (114)	7 1/2 (191)	6 (152)	6 1/2 (165)	8 3/4 (222)	6 3/4 (171)	12 (305)	10 (254)	8 (203)	9 (229)
Min. edge distance	$c_{min}$	In. (mm)	8 (203)	2 1/2 (64)	2 1/2 (64)	2 3/4 (70)	2 3/8 (60)	3 5/8 (92)	3 1/4 (83)	9 1/2 (241)	4 3/4 (121)	4 1/8 (105)					
	for $s \geq$	in. (mm)	8 (203)	5 (127)	5 (127)	5 3/4 (146)	5 3/4 (146)	6 1/8 (156)	5 7/8 (149)	5 (127)	10 1/2 (267)	8 7/8 (225)					
Min. anchor spacing	$s_{min}$	in. (mm)	8 (203)	2 1/2 (64)	2 1/2 (64)	2 3/4 (70)	2 3/8 (60)	3 1/2 (89)	3 (76)	5 (127)	5 (127)	4 (102)					
	for $c \geq$	In. (mm)	8 (203)	3 5/8 (92)	3 5/8 (92)	4 1/8 (105)	3 1/2 (89)	4 3/4 (121)	4 1/4 (108)	9 1/2 (241)	9 1/2 (241)	7 3/4 (197)					
Min. hole depth in concrete	$h_o$	in. (mm)	2 (51)	2 5/8 (67)	3 3/8 (86)	2 5/8 (67)	4 (102)	3 3/4 (98)	4 3/4 (121)	4 (102)	4 1/2 (117)	5 3/4 (146)					
Min. specified yield strength	$f_y$	lb/in <sup>2</sup> (N/mm <sup>2</sup> )	100,000 (690)			84,800 (585)			84,800 (585)			84,800 (585)					
Min. specified ult. strength	$f_{uta}$	lb/in <sup>2</sup> (N/mm <sup>2</sup> )	125,000 (862)			106,000 (731)			106,000 (731)			106,000 (731)					
Effective tensile stress area	$A_{se,N}$	ln <sup>2</sup> (mm <sup>2</sup> )	0.052 (33.6)			0.101 (65.0)			0.162 (104.6)			0.237 (152.8)					
Steel strength in tension	$N_{sa}$	lb (kN)	6,500 (28.9)			10,705 (47.6)			17,170 (76.4)			25,120 (111.8)					
Steel strength in shear	$V_{sa}$	lb (kN)	2,180 (9.7)	3,595 (16.0)		5,495 (24.4)			8,090 (36.0)			13,675 (60.8)					
Steel strength in shear, seismic <sup>3</sup>	$V_{sa,eq}$	lb (kN)	2,180 (9.7)	2,255 (10.0)		5,495 (24.4)			7,600 (33.8)			11,745 (52.2)					
Pullout strength uncracked concrete <sup>4</sup>	$N_{p,uncr}$	lb (kN)	2,160 (9.6)	2,515 (11.2)	4,110 (18.3)	NA	5,515 (24.5)	NA	9,145 (40.7)	NA	8,280 (36.8)	10,680 (47.5)					
Pullout strength cracked concrete <sup>4</sup>	$N_{p,cr}$	lb (kN)	NA	2,270 (10.1)	3,160 (14.1)	NA	4,915 (21.9)	NA	NA	NA	NA	NA					
Anchor category <sup>5</sup>			2	1													
Effectiveness factor $k_{uncr}$ uncracked concrete			24														
Effectiveness factor $k_{cr}$ cracked concrete <sup>6</sup>			17														
$\Psi_{c,N} = k_{uncr}/k_{cr}$ <sup>7</sup>			1.0														
Coefficient for prying strength, $k_{cp}$			1.0	2.0	1.0	2.0											
Strength reduction factor $\phi$ for tension, steel failure modes <sup>8</sup>			0.75														
Strength reduction factor $\phi$ for shear, steel failure modes <sup>8</sup>			0.65														
Strength reduction $\phi$ factor for tension, concrete failure modes or pullout, Condition B <sup>9</sup>			0.55	0.65													
Strength reduction $\phi$ factor for shear, concrete failure modes, Condition B <sup>9</sup>			0.70														
Axial stiffness in service load range <sup>10</sup>	$\beta_{uncr}$	lb/in.	600,000														
	$\beta_{cr}$	lb/in.	135,000														

For SI: 1 inch = 25.4 mm, 1 lbf = 4.45 N, 1 psi = 0.006895 MPa. For pound-inch units: 1 mm = 0.03937 inches.

<sup>1</sup>See Fig. 2.  
<sup>2</sup>For sand-lightweight or normal-weight concrete over metal deck, see Figures 5A, 5B, 5C and 5D and Tables 5 and 6.  
<sup>3</sup>See Section 4.1.8 of this report.  
<sup>4</sup>For all design cases  $\Psi_{c,P} = 1.0$ . NA (not applicable) denotes that this value does not control for design. See Section 4.1.4 of this report.  
<sup>5</sup>See ACI 318-14 17.3.3 or ACI 318-11 D.4.3, as applicable.  
<sup>6</sup>See ACI 318-14 17.4.2.2 or ACI 318-11 D.5.2.2, as applicable.  
<sup>7</sup>For all design cases  $\Psi_{c,N} = 1.0$ . The appropriate effectiveness factor for cracked concrete ( $k_{cr}$ ) or uncracked concrete ( $k_{uncr}$ ) must be used.  
<sup>8</sup>The KB-TZ is a ductile steel element as defined by ACI 318-14 2.3 or ACI 318-11 D.1, as applicable.  
<sup>9</sup>For use with the load combinations of ACI 318-14 Section 5.3 or ACI 318-11 Section 9.2, as applicable. Condition B applies where supplementary reinforcement in conformance with ACI 318-14 17.3.3(c) or ACI 318-11 D.4.3(c), as applicable, is not provided, or where pullout or prying strength governs. For cases where the presence of supplementary reinforcement can be verified, the strength reduction factors associated with Condition A may be used.  
<sup>10</sup>Mean values shown, actual stiffness may vary considerably depending on concrete strength, loading and geometry of application.



TABLE 4—DESIGN INFORMATION, STAINLESS STEEL KB-TZ

DESIGN INFORMATION	Symbol	Units	Nominal anchor diameter											
			3/8		1/2		5/8			3/4				
Anchor O.D.	$d_a$	in. (mm)	0.375 (9.5)		0.5 (12.7)		0.625 (15.9)			0.75 (19.1)				
Effective min. embedment <sup>1</sup>	$h_{ef}$	in. (mm)	2 (51)		2 (51)		3/4 (83)		3/8 (79)	4 (102)		3/4 (95)		4/4 (121)
Min. member thickness	$h_{min}$	in. (mm)	4 (102)	5 (127)	4 (102)	6 (152)	6 (152)	8 (203)	5 (127)	6 (152)	8 (203)	6 (152)	8 (203)	8 (203)
Critical edge distance	$c_{ac}$	in. (mm)	4 3/8 (111)	3 7/8 (98)	5 1/2 (140)	4 1/2 (114)	7 1/2 (191)	6 (152)	7 (178)	8 7/8 (225)	6 (152)	10 (254)	7 (178)	9 (229)
Min. edge distance	$c_{min}$	in. (mm)	2 1/2 (64)		2 7/8 (73)		2 1/8 (54)		3 1/4 (83)	2 3/8 (60)		4 1/4 (108)		4 (102)
	for $s \geq$	in. (mm)	5 (127)		5 3/4 (146)		5 1/4 (133)		5 1/2 (140)	5 1/2 (140)		10 (254)		8 1/2 (216)
Min. anchor spacing	$s_{min}$	in. (mm)	2 1/4 (57)		2 7/8 (73)		2 (51)		2 3/4 (70)	2 3/8 (60)		5 (127)		4 (102)
	for $c \geq$	in. (mm)	3 1/2 (89)		4 1/2 (114)		3 1/4 (83)		4 1/8 (105)	4 1/4 (108)		9 1/2 (241)		7 (178)
Min. hole depth in concrete	$h_o$	in. (mm)	2 5/8 (67)		2 5/8 (67)		4 (102)		3 3/4 (98)	4 3/4 (121)		4 1/2 (117)		5 3/4 (146)
Min. specified yield strength	$f_y$	lb/in <sup>2</sup> (N/mm <sup>2</sup> )	92,000 (634)		92,000 (634)		92,000 (634)			76,125 (525)				
Min. specified ult. Strength	$f_{uta}$	lb/in <sup>2</sup> (N/mm <sup>2</sup> )	115,000 (793)		115,000 (793)		115,000 (793)			101,500 (700)				
Effective tensile stress area	$A_{se,N}$	in <sup>2</sup> (mm <sup>2</sup> )	0.052 (33.6)		0.101 (65.0)		0.162 (104.6)			0.237 (152.8)				
Steel strength in tension	$N_{sa}$	lb (kN)	5,968 (26.6)		11,554 (51.7)		17,880 (82.9)			24,055 (107.0)				
Steel strength in shear	$V_{sa}$	lb (kN)	4,720 (21.0)		6,880 (30.6)		9,870 (43.9)			15,711 (69.9)				
Pullout strength in tension, seismic <sup>2</sup>	$N_{p,eq}$	lb (kN)	2,340 (10.4)		2,735 (12.2)		NA		NA	5,840 (26.0)		8,110 (36.1)		NA
Steel strength in shear, seismic <sup>2</sup>	$V_{sa,eq}$	lb (kN)	2,825 (12.6)		6,880 (30.6)		9,350 (41.6)			12,890 (57.3)				
Pullout strength uncracked concrete <sup>3</sup>	$N_{p,uncr}$	lb (kN)	2,630 (11.7)		NA		5,760 (25.6)		NA			NA		12,040 (53.6)
Pullout strength cracked concrete <sup>3</sup>	$N_{p,cr}$	lb (kN)	2,340 (10.4)		3,180 (14.1)		NA		NA	5,840 (26.0)		8,110 (36.1)		NA
Anchor category <sup>4</sup>			1		2		1							
Effectiveness factor $k_{uncr}$ uncracked concrete			24											
Effectiveness factor $k_{cr}$ cracked concrete <sup>5</sup>			17		24		17		17	17		24		17
$\Psi_{C,N} = k_{uncr}/k_{cr}$ <sup>6</sup>			1.0											
Strength reduction factor $\phi$ for tension, steel failure modes <sup>7</sup>			0.75											
Strength reduction factor $\phi$ for shear, steel failure modes <sup>7</sup>			0.65											
Strength reduction $\phi$ factor for tension, concrete failure modes, Condition B <sup>8</sup>			0.65		0.55		0.65							
Coefficient for pryout strength, $k_{cp}$			1.0				2.0							
Strength reduction $\phi$ factor for shear, concrete failure modes, Condition B <sup>8</sup>			0.70											
Axial stiffness in service load range <sup>9</sup>	$\beta_{uncr}$	lb/in.	120,000											
	$\beta_{cr}$	lb/in.	90,000											

For SI: 1 inch = 25.4 mm, 1 lbf = 4.45 N, 1 psi = 0.006895 MPa For pound-inch units: 1 mm = 0.03937 inches.

<sup>1</sup>See Fig. 2.

<sup>2</sup>See Section 4.1.8 of this report. NA (not applicable) denotes that this value does not control for design.

<sup>3</sup>For all design cases  $\Psi_{C,P}=1.0$ . NA (not applicable) denotes that this value does not control for design. See Section 4.1.4 of this report.

<sup>4</sup>See ACI 318-14 17.3.3 or ACI 318-11 D.4.3, as applicable.

<sup>5</sup>See ACI 318-14 17.4.2.2 or ACI 318-11 D.5.2.2, as applicable.

<sup>6</sup>For all design cases  $\Psi_{C,N}=1.0$ . The appropriate effectiveness factor for cracked concrete ( $k_{cr}$ ) or uncracked concrete ( $k_{uncr}$ ) must be used.

<sup>7</sup>The KB-TZ is a ductile steel element as defined by ACI 318 D.1.

<sup>8</sup>For use with the load combinations of ACI 318-14 Section 5.3 or ACI 318-11 Section 9.2, as applicable. Condition B applies where supplementary reinforcement in conformance with ACI 318-14 17.3.3(c) or ACI 318-11 D.4.3(c), as applicable, is not provided, or where pullout or pryout strength governs. For cases where the presence of supplementary reinforcement

can be verified, the strength reduction factors associated with Condition A may be used.

<sup>9</sup>Mean values shown, actual stiffness may vary considerably depending on concrete strength, loading and geometry of application.

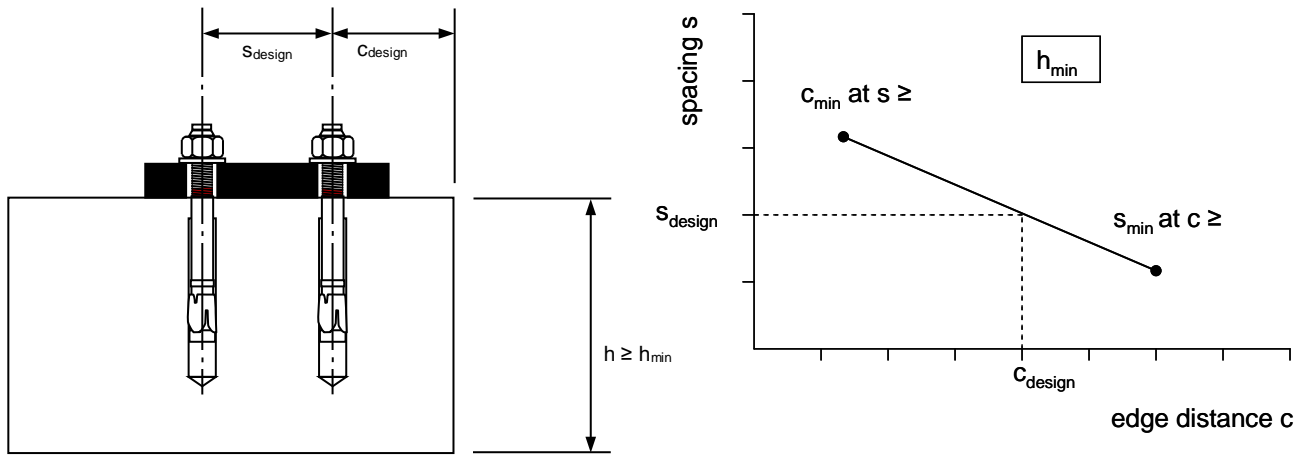

FIGURE 4—INTERPOLATION OF MINIMUM EDGE DISTANCE AND ANCHOR SPACING

TABLE 5—HILTI KWIK BOLT TZ (KB-TZ) CARBON STEEL ANCHORS TENSION AND SHEAR DESIGN DATA FOR INSTALLATION IN THE SOFFIT OF CONCRETE-FILLED PROFILE STEEL DECK ASSEMBLIES<sup>1,6,7,8</sup>

DESIGN INFORMATION	Symbol	Units	Anchor Diameter								
			3/8		1/2		5/8		3/4		
Effective Embedment Depth	$h_{ef}$	in.	1 1/2	2	2 3/4	2	3 1/4	3 1/8	4	3 1/4	3 3/4
Minimum Hole Depth	$h_o$	in.	2	2 5/8	3 3/8	2 5/8	4	3 3/4	4 3/4	4	4 1/2
Loads According to Figure 5A											
Pullout Resistance, uncracked concrete <sup>5</sup>	$N_{p,deck,un-cr}$	lb	1,365	2,060	3,070	2,060	3,695	2,825	6,555	4,230	4,255
Pullout Resistance, cracked concrete <sup>6</sup>	$N_{p,deck,cr}$	lb	1,145	1,460	2,360	1,460	2,620	2,000	4,645	3,000	3,170
Steel Strength in Shear <sup>7</sup>	$V_{sa,deck}$	lb	1,745	2,130	2,715	3,000	4,945	4,600	6,040	4,840	6,190
Steel Strength in Shear, Seismic <sup>8</sup>	$V_{sa,deck,eq}$	lb	1,340	1,340	1,710	3,000	4,945	4,320	5,675	3,870	5,315
Loads According to Figure 5B											
Pullout Resistance, uncracked concrete <sup>5</sup>	$N_{p,deck,un-cr}$	lb	1,365	2,010	3,070	2,010	3,695	2,825	5,210	4,230	4,255
Pullout Resistance, cracked concrete <sup>6</sup>	$N_{p,deck,cr}$	lb	1,145	1,425	2,360	1,425	2,620	2,000	3,875	3,000	3,170
Steel Strength in Shear <sup>7</sup>	$V_{sa,deck}$	lb	1,745	2,130	2,715	2,600	4,065	4,600	5,615	4,840	6,190
Steel Strength in Shear, Seismic <sup>8</sup>	$V_{sa,deck,eq}$	lb	1,340	1,340	1,710	2,600	4,065	4,320	5,275	3,870	5,315
Loads According to Figure 5C											
Pullout Resistance, uncracked concrete <sup>5</sup>	$N_{p,deck,un-cr}$	lb	1,285	1,845		1,865	3,375	4,065			
Pullout Resistance, cracked concrete <sup>6</sup>	$N_{p,deck,cr}$	lb	1,080	1,660		1,325	3,005	2,885			
Steel Strength in Shear <sup>7</sup>	$V_{sa,deck}$	lb	1,845	2,845		2,585	3,945	4,705			
Steel Strength in Shear, Seismic <sup>8</sup>	$V_{sa,deck,eq}$	lb	1,790	1,790		2,585	3,945	4,420			

<sup>1</sup>Installations must comply with Sections 4.1.10 and 4.3 and Figures 5A, 5B and 5C of this report.

<sup>2</sup>The values for  $\phi_p$  in tension and  $\phi_{sa}$  in shear can be found in Table 3 of this report.

<sup>3</sup>Characteristic pullout resistance for concrete compressive strengths greater than 3,000 psi may be increased by multiplying the value in the table by  $(f'c / 3000)^{1/2}$  for psi or  $(f'c / 20.7)^{1/2}$  for MPa [minimum of 24 MPa is required under ADIBC Appendix L, Section 5.1.1].

<sup>4</sup>Evaluation of concrete breakout capacity in accordance with ACI 318-14 17.4.2, 17.5.2 and 17.5.3 or ACI 318-11 D.5.2, D.6.2, and D.6.3, as applicable, is not required for anchors installed in the deck soffit.

<sup>5</sup>The values listed must be used in accordance with Section 4.1.4 of this report.

<sup>6</sup>The values listed must be used in accordance with Sections 4.1.4 and 4.1.8.2 of this report.

<sup>7</sup>The values listed must be used in accordance with Section 4.1.5 of this report.

<sup>8</sup>The values listed must be used in accordance with Section 4.1.8.3 of this report. Values are applicable to both static and seismic load combinations.

**TABLE 6—HILTI KWIK BOLT TZ (KB-TZ) CARBON STEEL ANCHORS SETTING INFORMATION FOR INSTALLATION ON THE TOP OF CONCRETE-FILLED PROFILE STEEL DECK ASSEMBLIES ACCORDING TO FIGURE 5D<sup>1,2,3,4</sup>**

DESIGN INFORMATION	Symbol	Units	Nominal anchor diameter		
			$\frac{3}{8}$	$\frac{1}{2}$	$\frac{1}{2}$
Effective Embedment Depth	$h_{ef}$	in.	1½	2	2
Nominal Embedment Depth	$h_{nom}$	in.	1 <sup>13/16</sup>	2 <sup>5/16</sup>	2 <sup>3/8</sup>
Minimum Hole Depth	$h_0$	in.	2	2 <sup>5/8</sup>	2 <sup>5/8</sup>
Minimum concrete thickness <sup>5</sup>	$h_{min,deck}$	in.	2¼	3¼	3¼
Critical edge distance	$C_{ac,deck,top}$	in.	8	4½	6
Minimum edge distance	$C_{min,deck,top}$	in.	16	3	4½
Minimum spacing	$S_{min,deck,top}$	in.	8	4	6½
Required Installation Torque	$T_{inst}$	ft-lb	25	25	40

<sup>1</sup>Installation must comply with Sections 4.1.10 and 4.3 and Figure 5D of this report.  
<sup>2</sup>For all other anchor diameters and embedment depths refer to Table 3 and 4 for applicable values of  $h_{min}$ ,  $C_{min}$ , and  $S_{min}$ .  
<sup>3</sup>Design capacity shall be based on calculations according to values in Table 3 of this report.  
<sup>4</sup>Applicable for  $\frac{3}{4}$ -in  $\leq h_{min,deck} < 4$ -in. For  $h_{min,deck} \geq 4$ -inch use setting information in Table 3 of this report.  
<sup>5</sup>Minimum concrete thickness refers to concrete thickness above upper flute. See Figure 5D.

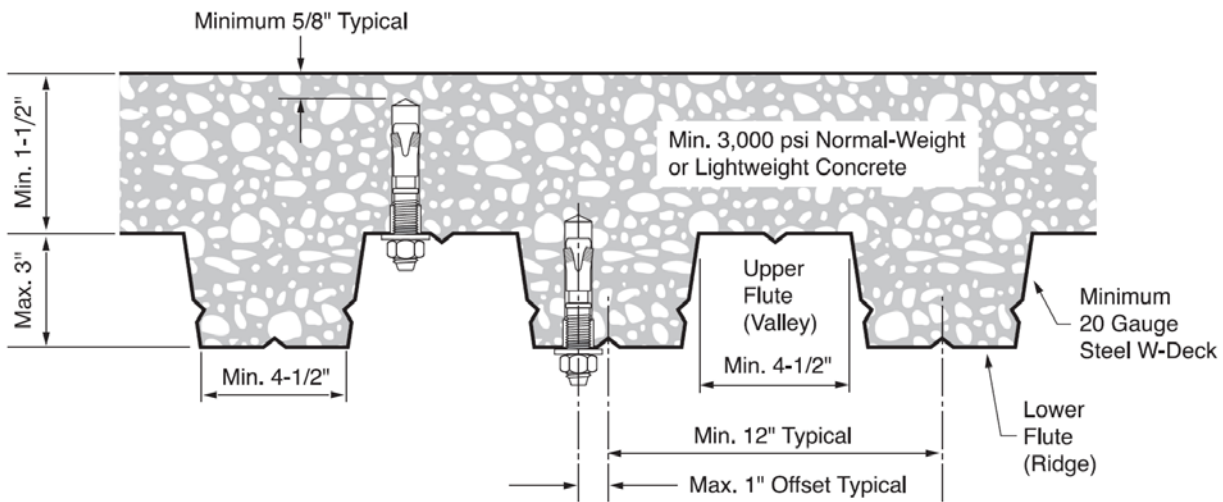

**FIGURE 5A—INSTALLATION IN THE SOFFIT OF CONCRETE OVER METAL DECK FLOOR AND ROOF ASSEMBLIES – W DECK<sup>1</sup>**

<sup>1</sup>Anchors may be placed in the upper or lower flute of the steel deck profile provided the minimum hole clearance is satisfied.

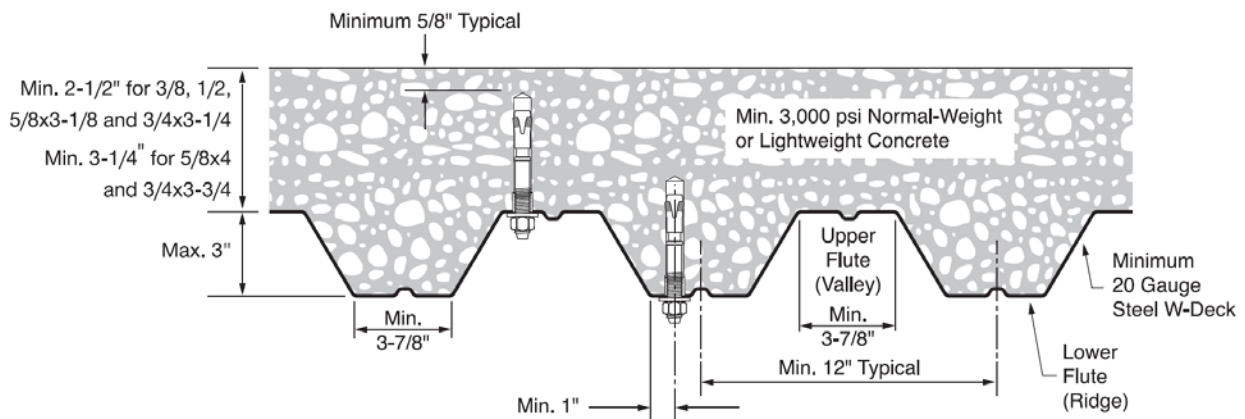

**FIGURE 5B—INSTALLATION IN THE SOFFIT OF CONCRETE OVER METAL DECK FLOOR AND ROOF ASSEMBLIES – W DECK<sup>1</sup>**

<sup>1</sup>Anchors may be placed in the upper or lower flute of the steel deck profile provided the minimum hole clearance is satisfied.

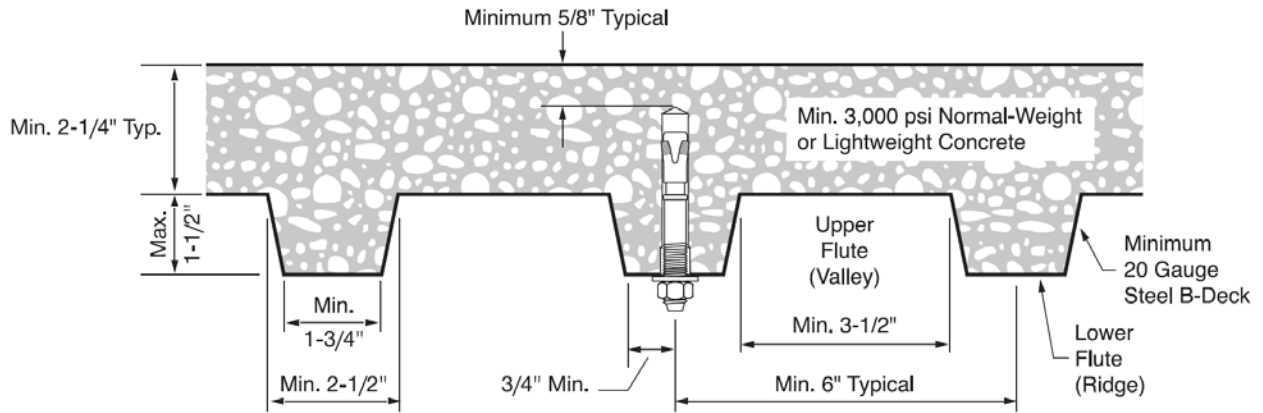

**FIGURE 5C—INSTALLATION IN THE SOFFIT OF CONCRETE OVER METAL DECK FLOOR AND ROOF ASSEMBLIES – B DECK<sup>1,2</sup>**

<sup>1</sup>Anchors may be placed in the upper or lower flute of the steel deck profile provided the minimum hole clearance is satisfied. Anchors in the lower flute may be installed with a maximum 1/8-inch offset in either direction from the center of the flute. The offset distance may be increased proportionally for profiles with lower flute widths greater than those shown provided the minimum lower flute edge distance is also satisfied.

<sup>2</sup>Anchors may be placed in the upper flute of the steel deck profiles in accordance with Figure 5B provided the concrete thickness above the upper flute is minimum 2 1/4-inch and the minimum hole clearance of 5/8-inch is satisfied.

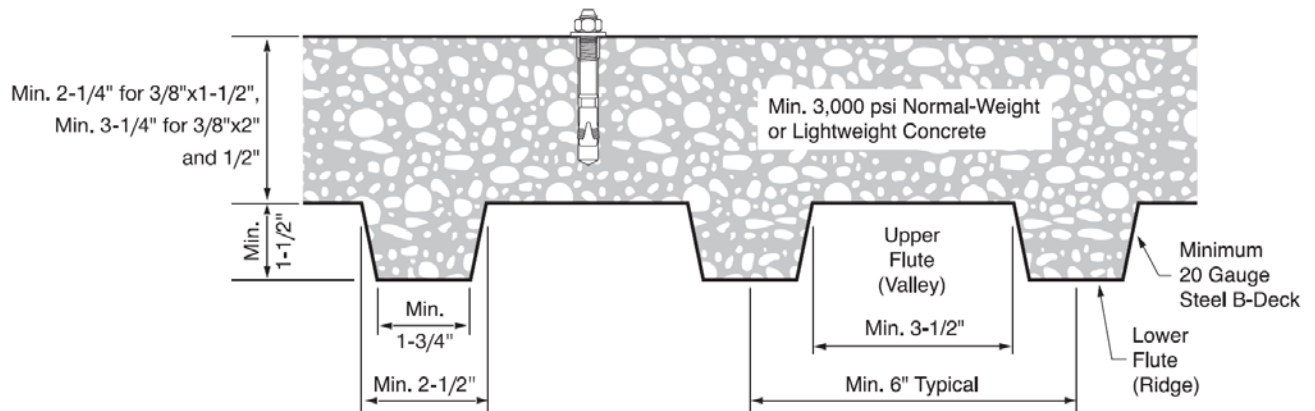

**FIGURE 5D—INSTALLATION ON THE TOP OF CONCRETE OVER METAL DECK FLOOR AND ROOF ASSEMBLIES – B DECK<sup>1,2</sup>**

<sup>1</sup>Refer to Table 6 for setting information for anchors in to the top of concrete over metal deck.

<sup>2</sup>Applicable for 2 1/4-in ≤ h<sub>min</sub> < 4-in for 3/8" x 1 1/2" anchors and 3 1/4-in ≤ h<sub>min</sub> < 4-in for 3/8" x 2" and 1/2" anchors. For h<sub>min</sub> ≥ 4-inch use setting information in Table 3 of this report.

TABLE 7—EXAMPLE ALLOWABLE LOAD VALUES FOR ILLUSTRATIVE PURPOSES

Nominal Anchor diameter (in.)	Embedment depth (in.)	Allowable tension (lbf)	
		Carbon Steel	Stainless Steel
		f'c = 2,500 psi	
3/8	1 1/2	800	NA
	2	1,105	1,155
	2 3/4	1,805	NA
1/2	2	1,490	1,260
	3 1/4	2,420	2,530
5/8	3 1/8	2,910	2,910
	4	4,015	4,215
3/4	3 1/4	3,085	NA
	3 3/4	3,635	3,825
	4 3/4	4,690	5,290

For SI: 1 lbf = 4.45 N, 1 psi = 0.00689 MPa 1 psi = 0.00689 MPa. 1 inch = 25.4 mm.

<sup>1</sup>Single anchors with static tension load only.

<sup>2</sup>Concrete determined to remain uncracked for the life of the anchorage.

<sup>3</sup>Load combinations from ACI 318-14 Section 5.3 or ACI 318-11 Section 9.2, as applicable (no seismic loading).

<sup>4</sup>30% dead load and 70% live load, controlling load combination 1.2D + 1.6 L.

<sup>5</sup>Calculation of the weighted average for  $\alpha = 0.3 \cdot 1.2 + 0.7 \cdot 1.6 = 1.48$ .

<sup>6</sup>f'c = 2,500 psi (normal weight concrete).

<sup>7</sup>C<sub>a1</sub> = C<sub>a2</sub> ≥ C<sub>ac</sub>

<sup>8</sup>h ≥ h<sub>min</sub>

<sup>9</sup>Values are for Condition B where supplementary reinforcement in accordance with ACI 318-14 17.3.3(c) or ACI 318-11 D.4.3(c) is not provided, as applicable.

<p><b>Hilti SafeSet™ System with Hollow Drill Bit</b></p>	 <p>Hilti TE-CD or TE-YD Hollow Carbide Drill Bit with a Hilti Vacuum (per section 4.3)</p>	
<p><b>Hilti SafeSet™ System with the Adaptive Torque Tool</b></p>	 <p>Hilti SIW-6AT-A22 Impact Wrench with the Hilti SI-AT-A22 Adaptive Torque Module</p>	
<p><b>Hilti Dust Removal Systems</b></p>	 <p>Hilti Rotary Hammer Drill with DRS (Dust Removal System) Module</p>	 <p>Hilti TE DRS-D Dust Removal System with Hilti Vacuum</p>

FIGURE 6—HILTI SYSTEM COMPONENTS

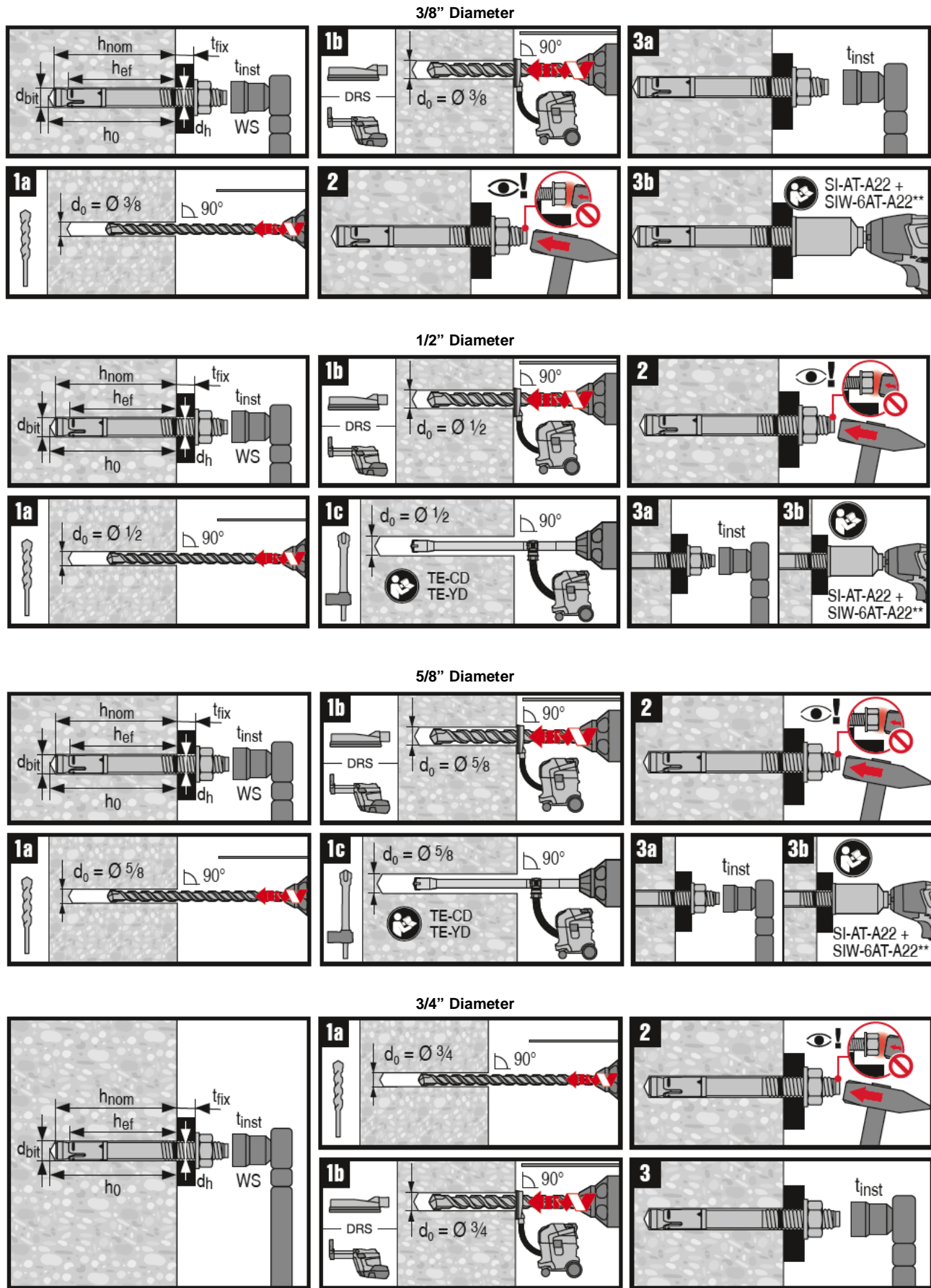

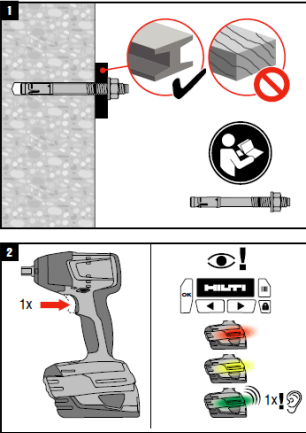

FIGURE 7—INSTALLATION INSTRUCTIONS



SI-AT-A22



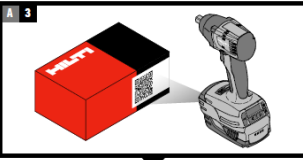

2151778 A2-08.2017

**A 3**



**4**

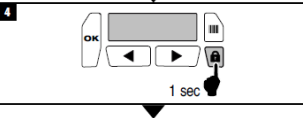

1 sec

**5**

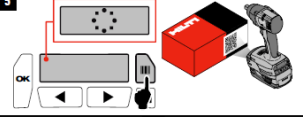

**6**

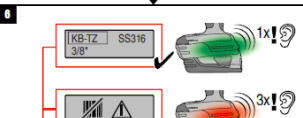

1x



**7**



**8**

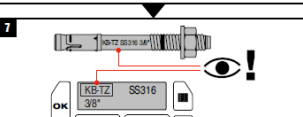

**B 3**

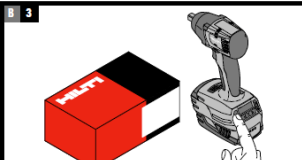

**4**

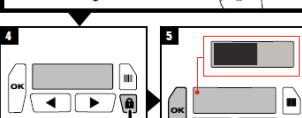

1 sec

**5**



**6**

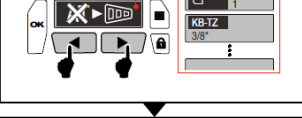

**7**

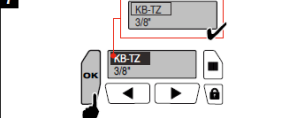

**8**

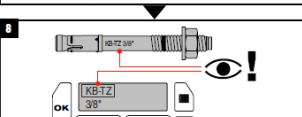

**C 3**

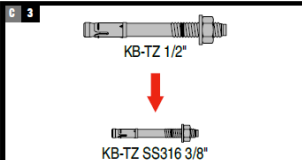

KB-TZ 1/2"

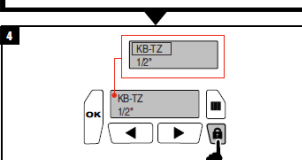

KB-TZ SS316 3/8"

**4**

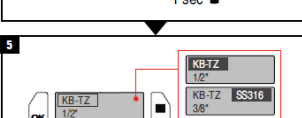

1 sec

**5**

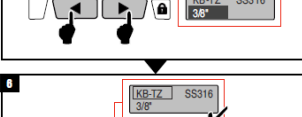

**6**

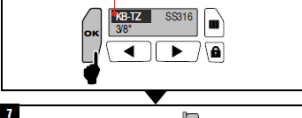

**7**

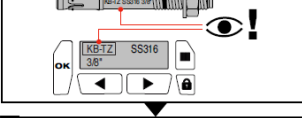

**8**

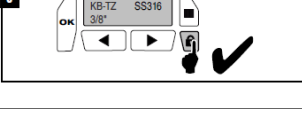

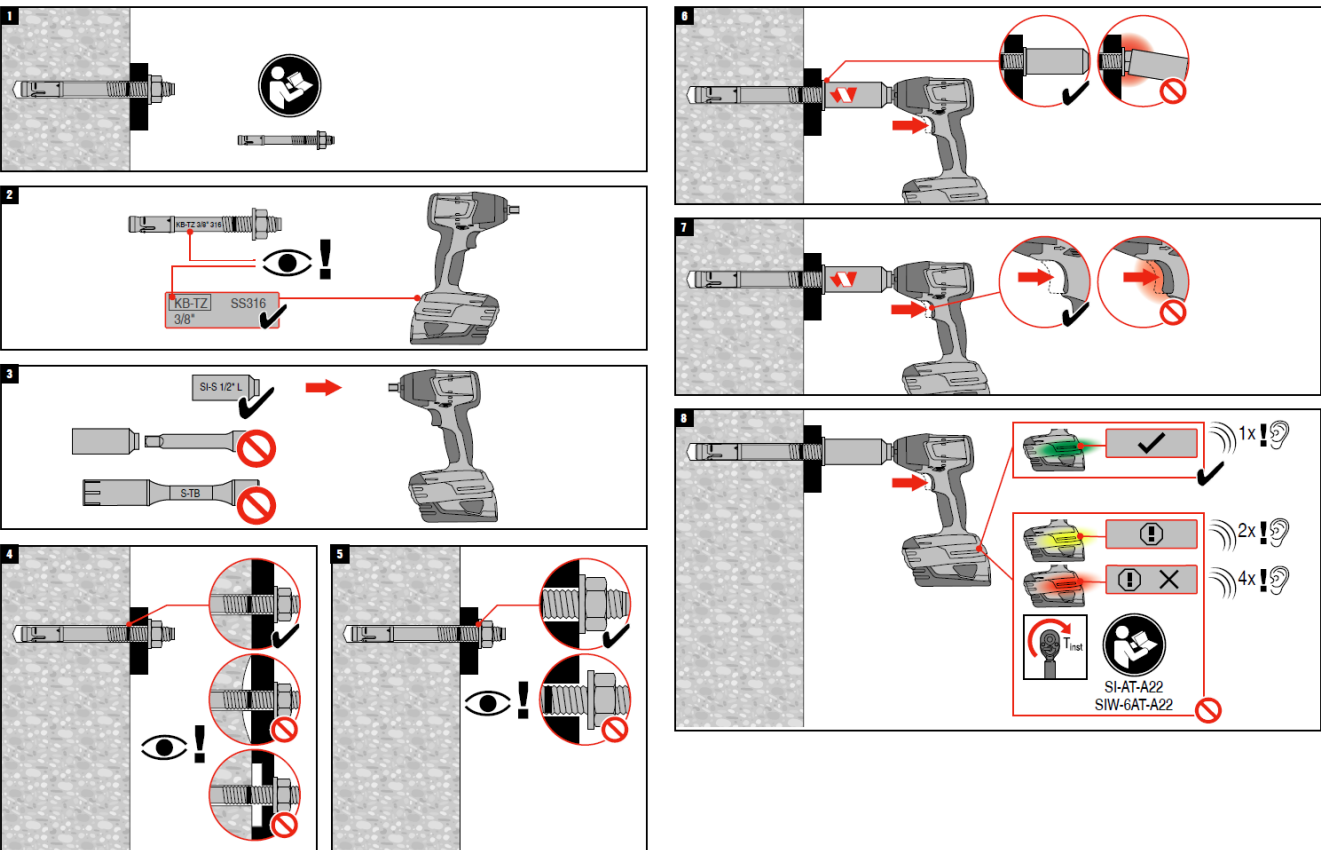
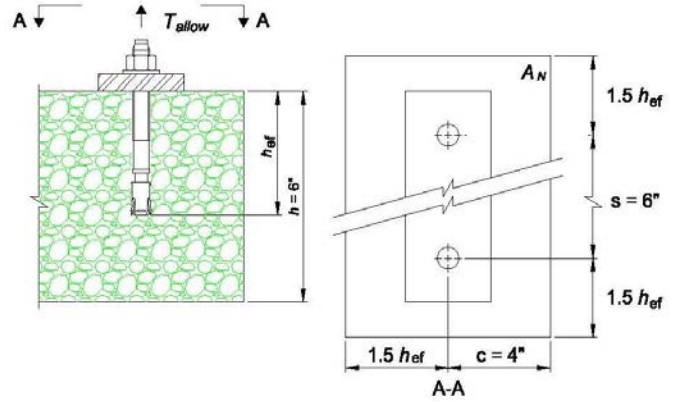

FIGURE 7A—INSTALLATION INSTRUCTIONS USING SI-AT-A22 ADAPTIVE TORQUE SYSTEM

**Given:**

Two 1/2-inch carbon steel KB-TZ anchors under static tension load as shown.  
 $h_{ef} = 3.25$  in.  
 Normal weight concrete,  $f'_c = 3,000$  psi  
 No supplementary reinforcement (Condition B per ACI 318-14 17.3.3(c) or ACI 318-11 D.4.3(c), as applicable)  
 Assume cracked concrete since no other information is available.



**Needed:** Using Allowable Stress Design (ASD) calculate the allowable tension load for this configuration.

Calculation per ACI 318-14 Chapter 17, ACI 318-11 Appendix D and this report.	ACI 318-14 Ref.	ACI 318-11 Ref.	Report Ref.
Step 1. Calculate steel capacity: $\phi N_s = \phi n A_{se} f_{ut} = 0.75 \times 2 \times 0.101 \times 106,000 = 16,059$ lb Check whether $f_{uta}$ is not greater than $1.9f_{ya}$ and 125,000 psi.	17.4.1.2 17.3.3(a)	D.5.1.2 D.4.3(a)	§4.1.2 Table 3
Step 2. Calculate concrete breakout strength of anchor in tension: $N_{cbg} = \frac{A_{Nc}}{A_{Nco}} \psi_{ec,N} \psi_{ed,N} \psi_{c,N} \psi_{cp,N} N_b$	17.4.2.1	D.5.2.1	§ 4.1.3
Step 2a. Verify minimum member thickness, spacing and edge distance: $h_{min} = 6$ in. $\leq 6$ in. $\therefore$ OK $\text{slope} = \frac{2.375 - 5.75}{3.5 - 2.375} = -3.0$ For $c_{min} = 4$ in $\Rightarrow$ $S_{min} = 5.75 - [(2.375 - 4.0)(-3.0)] = 0.875 < 2.375$ in $< 6$ in $\therefore$ ok	17.7	D.8	Table 3 Fig. 4
Step 2b. For $A_N$ check $1.5h_{ef} = 1.5(3.25) = 4.88$ in $> c$ $3.0h_{ef} = 3(3.25) = 9.75$ in $> s$	17.4.2.1	D.5.2.1	Table 3
Step 2c. Calculate $A_{Nco}$ and $A_{Nc}$ for the anchorage: $A_{Nco} = 9h_{ef}^2 = 9 \times (3.25)^2 = 95.1$ in. <sup>2</sup> $A_{Nc} = (1.5h_{ef} + c)(3h_{ef} + s) = [1.5 \times (3.25) + 4][3 \times (3.25) + 6] = 139.8$ in. <sup>2</sup> $< 2A_{Nco} \therefore$ ok	17.4.2.1	D.5.2.1	Table 3
Step 2d. Determine $\psi_{ec,N}$ : $e'_N = 0 \therefore \psi_{ec,N} = 1.0$	17.4.2.4	D.5.2.4	-
Step 2e. Calculate $N_b$ : $N_b = k_{cr} \lambda_{\alpha} \sqrt{f'_c} h_{ef}^{1.5} = 17 \times 1.0 \times \sqrt{3,000} \times 3.25^{1.5} = 5,456$ lb	17.4.2.2	D.5.2.2	Table 3
Step 2f. Calculate modification factor for edge distance: $\psi_{ed,N} = 0.7 + 0.3 \frac{4}{1.5(3.25)} = 0.95$	17.4.2.5	D.5.2.5	Table 3
Step 2g. Calculate modification factor for cracked concrete: $\psi_{c,N} = 1.00$ (cracked concrete)	17.4.2.6	D.5.2.6	Table 3
Step 2h. Calculate modification factor for splitting: $\psi_{cp,N} = 1.00$ (cracked concrete)	-	-	§ 4.1.10 Table 3
Step 2i. Calculate $\phi N_{cbg}$ : $\phi N_{cbg} = 0.65 \times \frac{139.8}{95.1} \times 1.00 \times 0.95 \times 1.00 \times 5,456 = 4,952$ lb	17.4.2.1 17.3.3(c)	D.5.2.1 D.4.3(c)	§ 4.1.3 Table 3
Step 3. Check pullout strength: Table 3, $\phi n N_{pn,fc} = 0.65 \times 2 \times 5,515$ lb $\times \sqrt{\frac{3,000}{2,500}} = 7,852$ lb $> 4,952 \therefore$ OK	17.4.3.2 17.3.3(c)	D.5.3.2 D.4.3(c)	§ 4.1.4 Table 3
Step 4. Controlling strength: $\phi N_{cbg} = 4,952$ lb $< \phi n N_{pn} < \phi N_s \therefore \phi N_{cbg}$ controls	17.3.1.2	D.4.1.2	Table 3
Step 5. To convert to ASD, assume $U = 1.2D + 1.6L$ : $T_{allow} = \frac{4,952}{1.48} = 3,346$ lb.	-	-	§ 4.2

FIGURE 8—EXAMPLE CALCULATION



**DIVISION: 03 00 00—CONCRETE**  
**Section: 03 16 00—Concrete Anchors**

**DIVISION: 05 00 00—METALS**  
**Section: 05 05 19—Post-Installed Concrete Anchors**

**REPORT HOLDER:**

HILTI, INC.

**EVALUATION SUBJECT:****HILTI KWIK BOLT TZ CARBON AND STAINLESS STEEL ANCHORS IN CRACKED AND UNCRACKED CONCRETE****1.0 REPORT PURPOSE AND SCOPE****Purpose:**

The purpose of this evaluation report supplement is to indicate that the Hilti KWIK BOLT TZ carbon and stainless steel anchors in cracked and uncracked concrete, described in ICC-ES evaluation report [ESR-1917](#), have also been evaluated for compliance with the codes noted below as adopted by Los Angeles Department of Building and Safety (LADBS).

**Applicable code editions:**

- 2020 *City of Los Angeles Building Code* (LABC)
- 2020 *City of Los Angeles Residential Code* (LARC)

**2.0 CONCLUSIONS**

The Hilti KWIK BOLT TZ carbon and stainless steel anchors in cracked and uncracked concrete, described in Sections 2.0 through 7.0 of the evaluation report [ESR-1917](#), comply with LABC Chapter 19, and LARC, and are subject to the conditions of use described in this report.

**3.0 CONDITIONS OF USE**

The Hilti KWIK BOLT TZ carbon and stainless steel anchors in cracked and uncracked concrete described in this evaluation report supplement must comply with all of the following conditions:

- All applicable sections in the evaluation report [ESR-1917](#).
- The design, installation, conditions of use and labeling of the anchors are in accordance with the 2018 *International Building Code*® (2018 IBC) provisions noted in the evaluation report [ESR-1917](#).
- The design, installation and inspection are in accordance with additional requirements of LABC Chapters 16 and 17, as applicable.
- Under the LARC, an engineered design in accordance with LARC Section R301.1.3 must be submitted.
- The allowable and strength design values listed in the evaluation report and tables are for the connection of the anchors to the concrete. The connection between the anchors and the connected members shall be checked for capacity (which may govern).
- For use in wall anchorage assemblies to flexible diaphragm applications, anchors shall be designed per the requirements of City of Los Angeles Information Bulletin P/BC 2020-071.

This supplement expires concurrently with the evaluation report, reissued May 2021.

**DIVISION: 03 00 00—CONCRETE**  
**Section: 03 16 00—Concrete Anchors**

**DIVISION: 05 00 00—METALS**  
**Section: 05 05 19—Post-Installed Concrete Anchors**

**REPORT HOLDER:**

HILTI, INC.

**EVALUATION SUBJECT:**

**HILTI KWIK BOLT TZ CARBON AND STAINLESS STEEL ANCHORS IN CRACKED AND UNCRACKED CONCRETE**

**1.0 REPORT PURPOSE AND SCOPE**

**Purpose:**

The purpose of this evaluation report supplement is to indicate that the Hilti Kwik Bolt TZ Carbon and Stainless Steel Anchors in cracked and uncracked Concrete, described in ICC-ES evaluation report ESR-1917, have also been evaluated for compliance with the codes noted below.

**Applicable code editions:**

- 2017 *Florida Building Code—Building*
- 2017 *Florida Building Code—Residential*

**2.0 CONCLUSIONS**

The Hilti Kwik Bolt TZ Anchor (KB-TZ), described in Sections 2.0 through 7.0 of the evaluation report ESR-1917, complies with the *Florida Building Code—Building* and the *Florida Building Code—Residential*, provided the design and installation are in accordance with the 2015 *International Building Code*® provisions noted in the evaluation report.

Use of the Hilti KB-TZ stainless steel anchors for use in exterior exposure and damp environments have also been found to be in compliance with the High-Velocity Hurricane Zone provisions of the *Florida Building Code—Building* and the *Florida Building Code—Residential*.

Use of the Hilti KB-TZ carbon steel anchors for use in dry, interior locations has also been found to be in compliance with the High-Velocity Hurricane Zone provisions of the *Florida Building Code—Building* and the *Florida Building Code—Residential*.

For products falling under Florida Rule 9N-3, verification that the report holder's quality-assurance program is audited by a quality-assurance entity approved by the Florida Building Commission for the type of inspections being conducted is the responsibility of an approved validation entity (or the code official, when the report holder does not possess an approval by the Commission).

This supplement expires concurrently with the evaluation report, reissued May 2021.